



Club Access Cargo Zip Pant - Style #CA003

SU2021, 2021-2022, AM475 - SU2021

Summary



Club Access Cargo Zip Pant

Name	Club Access Cargo Zip Pant
Style No.	CA003
Description	Cargo pants made with an outseam zippers and extra pockets for people with lower limb amputations.
Division	AM475 - SU2021
Season	SU2021
Year	2021-2022
Size Scale	M -Sample size

- XS
- S
- M
- L
- XL

AM475 ONLY - Student Name	Colin Humphreys
Factory	To Be Determined
COO	Vietnam
Main Fabric	Cotton
New/Carryover	New Style
Style Status	In Development
Sample Development Status	1st Sample
MSRP	79.97
Target Cost	14.79
Target Margin (%)	85
MOQ	3000
Leadtime	90 Days
Created by/Author	06-10-2021 Colin Humphreys chumps@rams.colostate.edu



CargoZipRender_Colorway A Copy 2



CargoZipRender_Colorway A Copy 2_2



CargoZipRender_Colorway A Copy 2_1



CargoZipRender_Colorway A Copy 1



CargoZipRender_Colorway A Copy 1_2



CargoZipRender_Colorway A Copy 1_1



CargoZipRender_Colorway A



CargoZipRender_Colorway A_2



CargoZipRender_Colorway A_1

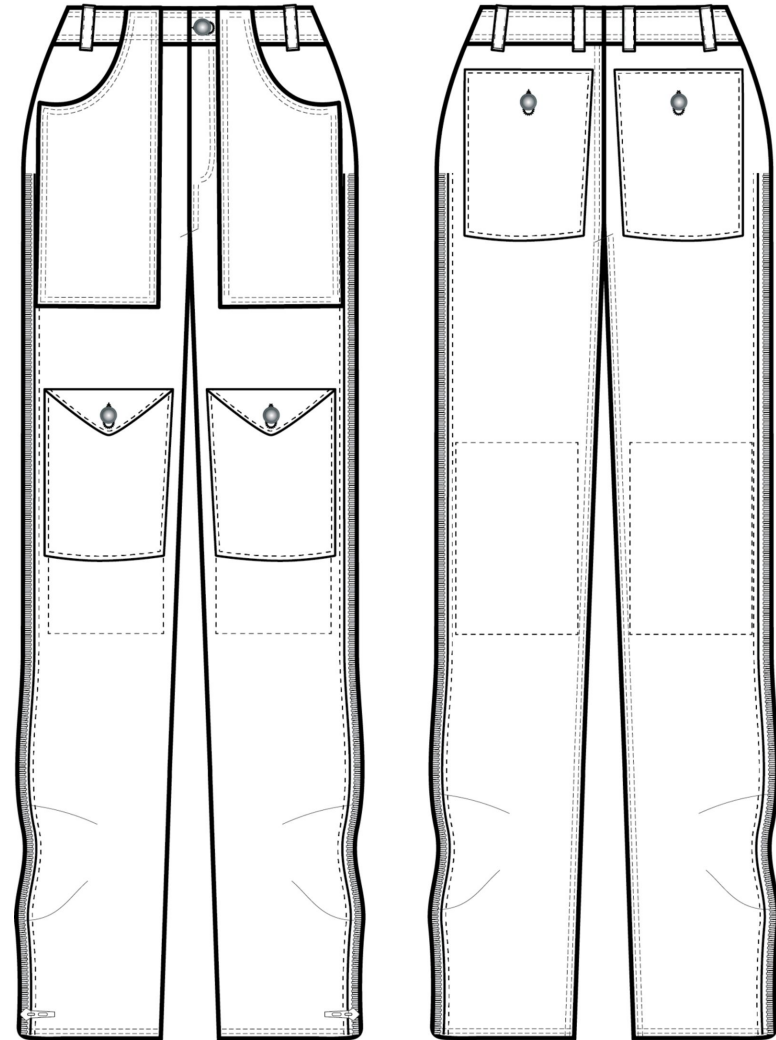

CargoZip



● Brown Rice CZ
Custom Code: 13-1105 TCX
Cargo Zip colorways_Colorway A_0



● Granite Gray CZ
Custom Code: 18-5204 TCX
Cargo Zip colorways_Colorway A Copy 1_1



● Serenity CZ
Custom Code: 15-3919 TCX
Cargo Zip colorways_Colorway A Copy 2_2

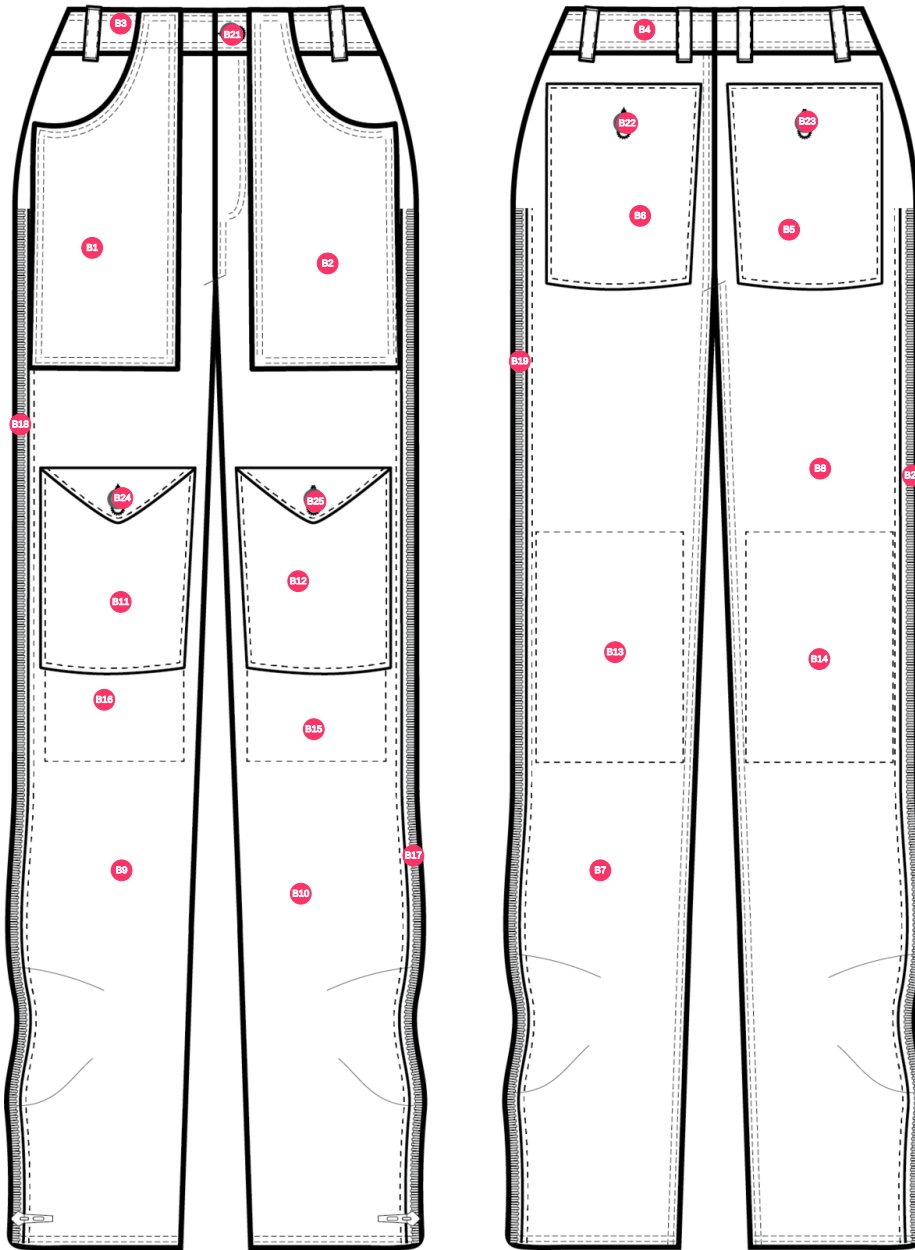

CargoZip (copy)

Components (25)

- B1** Heavy Cotton Twill - Colin
- B2** Heavy Cotton Twill - Colin
- B3** Heavy Cotton Twill - Colin
- B4** Heavy Cotton Twill - Colin
- B5** Heavy Cotton Twill - Colin
- B6** Heavy Cotton Twill - Colin
- B7** Heavy Cotton Twill - Colin
- B8** Heavy Cotton Twill - Colin
- B9** Heavy Cotton Twill - Colin
- B10** Heavy Cotton Twill - Colin
- B11** Heavy Cotton Twill - Colin
- B12** Heavy Cotton Twill - Colin
- B13** Nylon Lightweight Ripstop - Colin
- B14** Nylon Lightweight Ripstop - Colin
- B15** Nylon Lightweight Ripstop - Colin
- B16** Nylon Lightweight Ripstop - Colin
- B17** YKK Soft Touch Zipper - Colin
- B18** YKK Soft Touch Zipper - Colin
- B19** YKK Soft Touch Zipper - Colin
- B20** YKK Soft Touch Zipper - Colin
- B21** Buttons - Colin
- B22** Buttons - Colin
- B23** Buttons - Colin
- B24** Buttons - Colin
- B25** Buttons - Colin

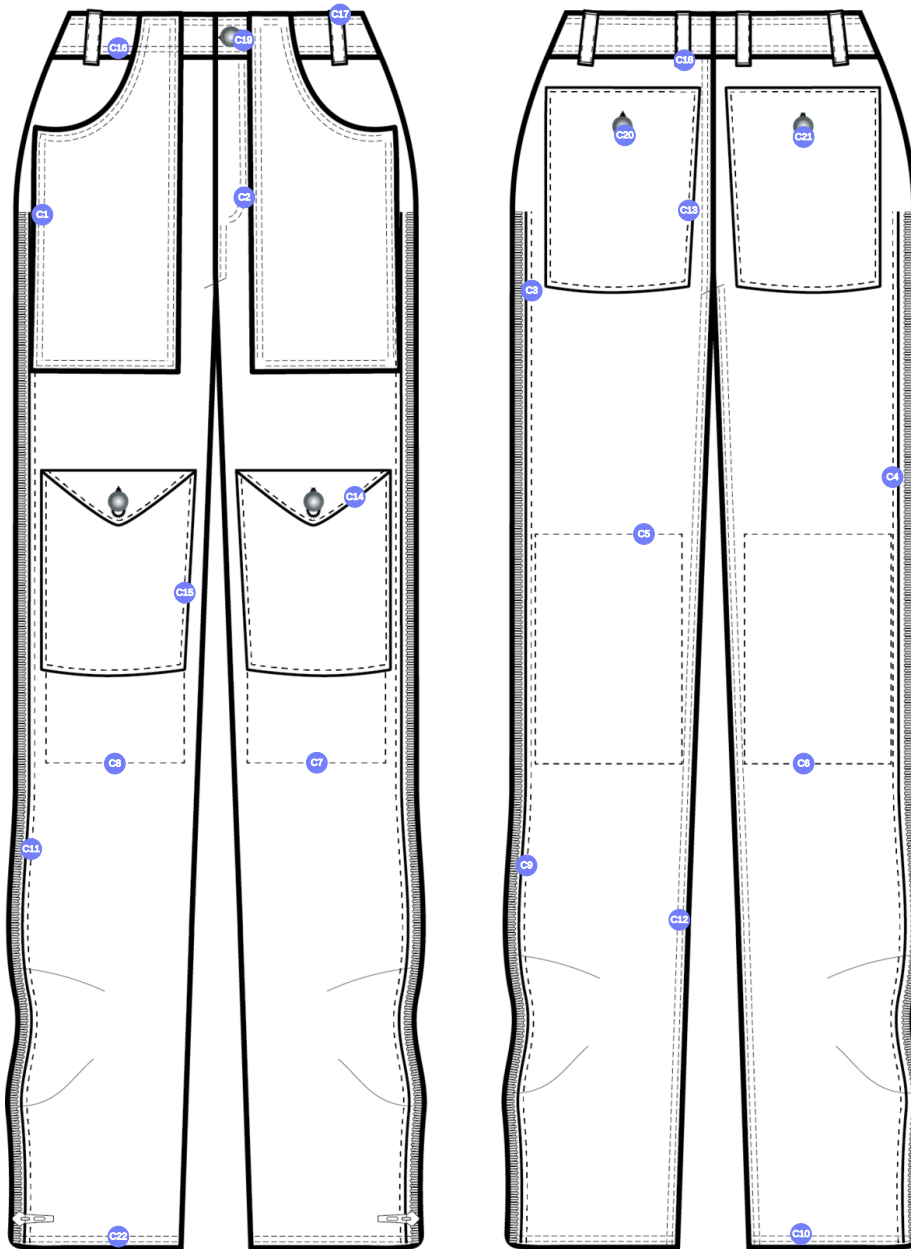

CargoZip (copy)

Construction Details (22)

- C1 406 Coverstitch
- C2 406 Coverstitch
- C3 1/8" 301 Lockstitch
- C4 1/8" 301 Lockstitch
- C5 301 topstitch
- C6 301 topstitch
- C7 301 topstitch
- C8 301 topstitch
- C9 1/8" 301 Lockstitch
- C10 406 Coverstitch
- C11 1/8" 301 Lockstitch
- C12 406 Coverstitch
- C13 1/8" 301 Lockstitch
- C14 1/8" 301 Lockstitch
- C15 1/8" 301 Lockstitch
- C16 406 Coverstitch
- C17 Bartack
- C18 Bartack
- C19 Keyhole Buttonhole
- C20 Keyhole Buttonhole
- C21 Keyhole Buttonhole
- C22 406 Coverstitch

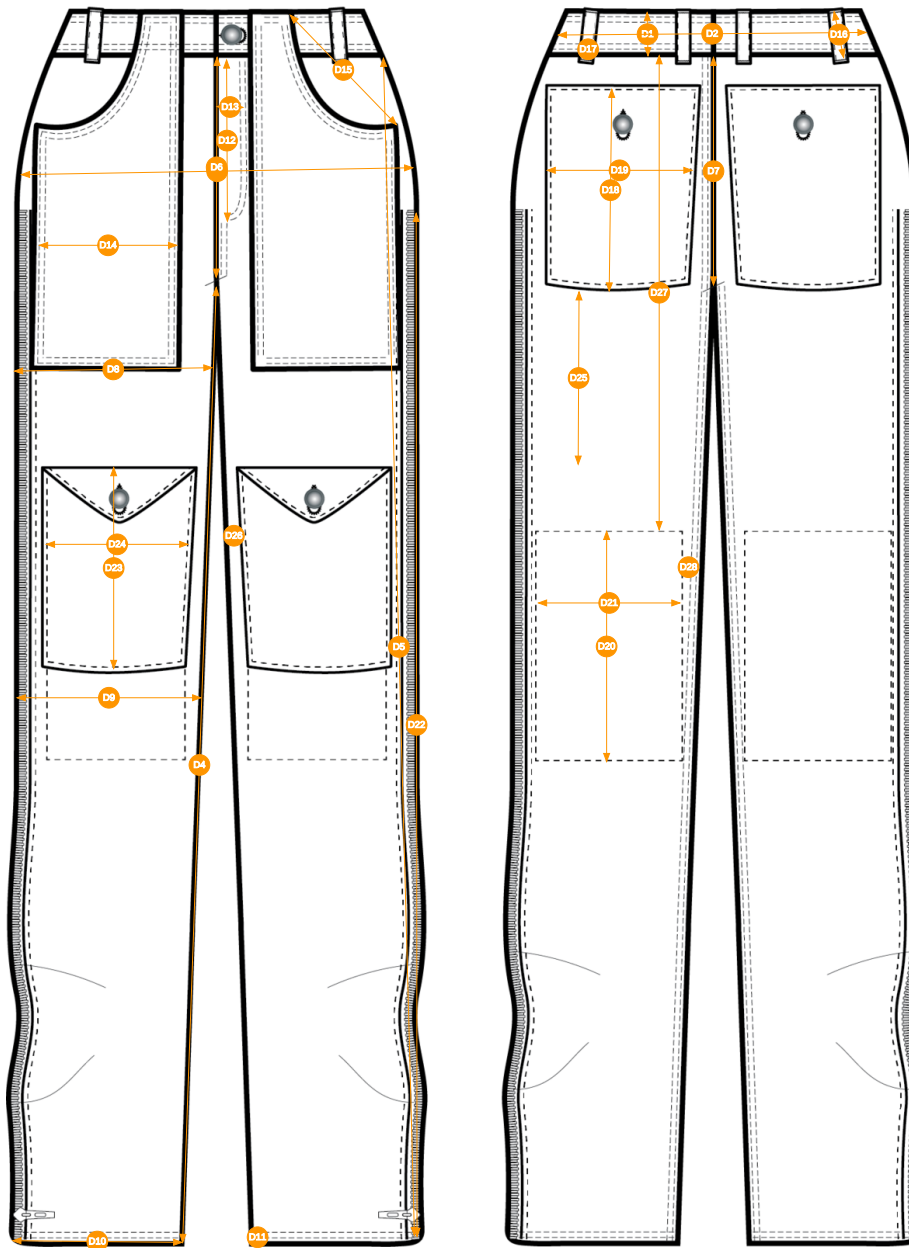

CargoZip (copy) (copy)

Points of measure (28)













- D1** Waistband Depth
- D2** Waistband Width Circumference (woven)
- D3** Hip Seat Width Circumference (woven pant)
- D4** Inseam
- D5** Outseam
- D6** Front Rise
- D7** Back Rise
- D8** Thigh Width Circumference (woven)
- D9** Knee Width Circumference (Woven)
- D10** Leg Opening Width Circumference (Woven)
- D11** Cuff Height Pants
- D12** Fly Zipper Length
- D13** Fly Zipper Width
- D14** Applied Pocket Width
- D15** Pocket Opening Within a Seam
- D16** Belt Loop Length
- D17** Belt Loop Width
- D18** Back Bottom Pocket Vertical
- D19** Back Bottom Pocket Horizontal
- D20** Knee Guard Height
- D21** Knee Guard Width
- D22** Outseam Zipper Length
- D23** Cargo Pocket Length
- D24** Cargo Pocket Width
- D25** Vertical Cargo Pocket Placement from Top of Back Pocket
- D26** Horizontal Cargo Pocket Placement from Inseam

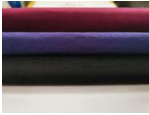

D27 Knee Guard Placement Vertical

D28 Horizontal Knee Guard Placement



THUMBNAIL	COMPONENT	QTY	SUPPLIER	COO	BROWN RICE CZ CODE: 13-1105 TCX	GRANITE GRAY CZ CODE: 18-5204 TCX	SERENITY CZ CODE: 15-3919 TCX	
FABRIC / BODY								
1	 <p>Heavy Cotton Twill - Colin CODE: S1yIT Placement: all over Notes: N/A Status : In Development Content (Fiber Content): 98% Cotton 2% Spandex Fabric Width: 56" Weight (GSM): 255 Dye Method: Piece Dyed AM475 - Student Name: Colin Humphreys</p>	1.252728 /m	To Be Determined	China	 Brown Rice CZ Custom Code: 13-1105 TCX Price: \$2.12	 Granite Gray CZ Custom Code: 18-5204 TCX Price: \$2.12	 Serenity CZ Custom Code: 15-3919 TCX Price: \$2.12	
2	 <p>Nylon Lightweight Ripstop - Colin CODE: NY001 Placement: sewn under cotton front and back knee Notes: N/A Status : In Development Content (Fiber Content): 100% Nylon Fabric Width: 58" Weight (GSM): 86 Finishes: Silicone coated Dye Method: Piece Dyed AM475 - Student Name: Colin Humphreys</p>	0.2286 /m	To Be Determined	China	 Brown Rice CZ Custom Code: 13-1105 TCX Price: \$1.72	 Granite Gray CZ Custom Code: 18-5204 TCX Price: \$1.72	 Serenity CZ Custom Code: 15-3919 TCX Price: \$1.72	
TRIM								
3	 <p>Fty Supply Thread CODE: zoSG08 Placement: all over Notes: N/A Status : In Development Content (Fiber Content): polyester Finishes: N/A Dye Method: Piece Dyed Size: TBD</p>	1 /kg	SML	USA	- DTM Price: \$0.08	- DTM Price: \$0.08	- DTM Price: \$0.08	
4	 <p>Buttons - Colin CODE: B2 Placement: Front cargo pockets, front waistband, and both back pockets Notes: N/A Status : In Development Content (Fiber Content): Zinc Alloy Finishes: Custom logo engraved Dye Method: N/A Size: 18 mm AM475 - Student Name: Colin Humphreys</p>	1 /Set	To Be Determined	China	 Brown Rice CZ Custom Code: 13-1105 TCX Price: \$0.04	 Granite Gray CZ Custom Code: 18-5204 TCX Price: \$0.04	 Serenity CZ Custom Code: 15-3919 TCX Price: \$0.04	







THUMBNAIL	COMPONENT	QTY	SUPPLIER	COO	BROWN RICE CZ CODE: 13-1105 TCX	GRANITE GRAY CZ CODE: 18-5204 TCX	SERENITY CZ CODE: 15-3919 TCX
5	 <p>YKK Soft Touch Zipper - Colin CODE: oyt50 Placement: 7 in down from the inseam to zip into shorts Notes: N/A Status : In Development Content (Fiber Content): Nylon Finishes: N/A Dye Method: N/A Size: 5 AM475 - Student Name: Colin Humphreys</p>	2 /Pieces	YKK	China	 Brown Rice CZ Custom Code: 13-1105 TCX Price: \$0.15	 Granite Gray CZ Custom Code: 18-5204 TCX Price: \$0.15	 Serenity CZ Custom Code: 15-3919 TCX Price: \$0.15
LABELS/PACKAGING							
6	 <p>Recyclable Mailer Poly Bag - Colin CODE: WTKLz Placement: for post production safe transportation Notes: N/A Status : In Development Content (Fiber Content): Polyethaline Finishes: N/A Dye Method: N/A Size: 28 x 28 cm AM475 - Student Name: Colin Humphreys</p>	1 /Pieces	To Be Determined	China	- Recyclable Mailer Poly Bag - Colin-WTKLz n/a Price: \$0.04	- Recyclable Mailer Poly Bag - Colin-WTKLz n/a Price: \$0.04	- Recyclable Mailer Poly Bag - Colin-WTKLz n/a Price: \$0.04
7	 <p>Recycled Hangtag Colin CODE: HT00 Placement: recycled cardstock hangtag Notes: N/A Status : In Development Content (Fiber Content): Recycled Cardstock Weight (GSM): 150 Finishes: Matte Dye Method: N/A Size: 1.5 x 3 In AM375 - Student Name: Colin Humphreys</p>	1 /Pieces	To Be Determined	China	- Recycled Hangtag Colin- HT00 n/a Price: \$0.08	- Recycled Hangtag Colin- HT00 n/a Price: \$0.08	- Recycled Hangtag Colin- HT00 n/a Price: \$0.08
8	 <p>Cardboard Box Eco - Colin CODE: B1 Placement: eco friendly box for shipping Notes: N/A Status : In Development Content (Fiber Content): N/A Finishes: N/A Dye Method: N/A Size: 14 x 12 AM475 - Student Name: Colin Humphreys</p>	1 /Pieces	To Be Determined	China	- Cardboard Box Eco - Colin- B1 n/a Price: \$0.3	- Cardboard Box Eco - Colin- B1 n/a Price: \$0.3	- Cardboard Box Eco - Colin- B1 n/a Price: \$0.3
9	 <p>Lop Fastener - Colin CODE: F1 Placement: Lop fastener for hangtag on CB neck Notes: N/A Status : In Development Content (Fiber Content): Plastic Finishes: N/A Dye Method: N/A Size: 2.5 in AM475 - Student Name: Colin Humphreys</p>	1 /Pieces	To Be Determined	China	- Lop Fastener - Colin- F1 n/a Price: \$0.001	- Lop Fastener - Colin- F1 n/a Price: \$0.001	- Lop Fastener - Colin- F1 n/a Price: \$0.001
10	 <p>Care Label Colin CODE: L001 Placement: Center back of the waistband Notes: N/A Status : In Development Content (Fiber Content): Polyester Finishes: N/A Dye Method: N/A Size: 3.5 x 10.5 cm</p>	1 /Pieces	To Be Determined	China	- Care Label Colin- L001 n/a Price: \$0.01	- Care Label Colin- L001 n/a Price: \$0.01	- Care Label Colin- L001 n/a Price: \$0.01



Club Access Cargo Zip Pant - Style #CA003

SU2021, 2021-2022, AM475 - SU2021

THUMBNAIL	COMPONENT	QTY	SUPPLIER	COO	BROWN RICE CZ CODE: 13-1105 TCX	GRANITE GRAY CZ CODE: 18-5204 TCX	SERENITY CZ CODE: 15-3919 TCX
11 	Garment Tag - Colin CODE: T001 Placement: Center back of the waistband over the care tag Notes: N/A Status : In Development Content (Fiber Content): Cloth Finishes: straight cut Dye Method: N/A Size: .5 x 1.5 in AM475 - Student Name: Colin Humphreys	1 /Pieces	To Be Determined	China	-  Brown Rice CZ Custom Code: 13-1105 TCX Price: \$0.05	-  Granite Gray CZ Custom Code: 18-5204 TCX Price: \$0.05	-  Serenity CZ Custom Code: 15-3919 TCX Price: \$0.05
Components 11					Total \$3.52	Total \$3.52	Total \$3.52



105.

Inseam

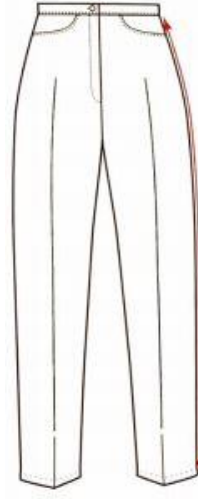

106.

Outseam

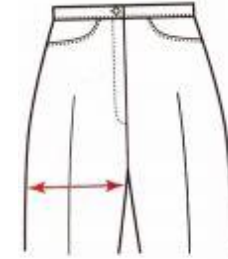

110.

Thigh Width Circumference (Woven)

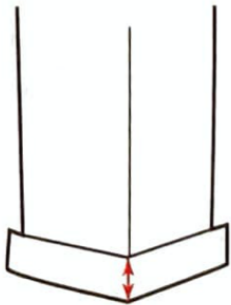

119.

Cuff Height Pants

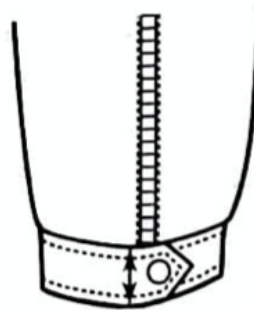

120.

Fly Zipper Length

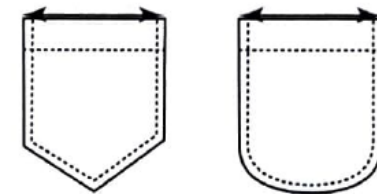

126.

Applied Pocket Width

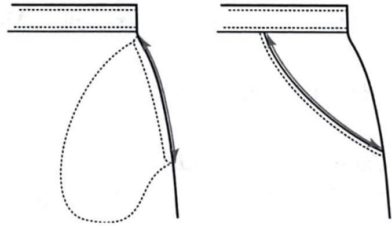

127.

Pocket Opening Within A Seam

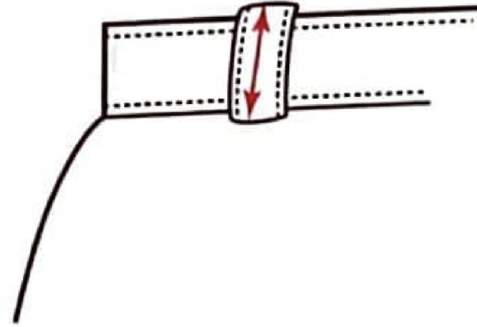

130.

Belt Loop Length

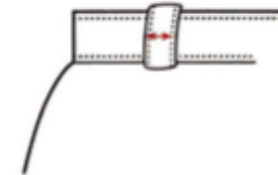

131.

Belt Loop Width



148e.

Back Bottom Pocket Vertical



148f.

Back Bottom Pocket Horizontal



128.

Applied Pocket Height



Sample Size: M

POINT OF MEASURE	CODE	HOW TO MEASURE	CRITICAL	TYPE	TOLERANCE	XS	S	M	L	XL
Waistband Depth	81	Measure from top of waistband edge straight down to bottom of waistband at waistband joining seam. [Note: If waistband is contoured, indicate measurement change on spec sheet.]	false	Full	0 in	0 in	0 in	1 3/8 in	0 in	1/8 in
Waistband Width Circumference (woven)	83	Measure from side of bottom band to side of bottom band along center of band, following natural contour of waistband. Reporting half of the circumference measurement.	false	Half	3/4 in	-1 in	-2 in	16 1/2 in	2 in	2 in
Hip Seat Width Circumference (woven pant)	93	Measure from edge of garment/side seam to edge of garment/side seam at a point up from crotch seam, following contour of waist. Reporting half of the circumference measurement.	true	Half	1 in	0 in	0 in	19 5/8 in	0 in	0 in
Inseam	105	Measure from crotch joining seam to bottom of leg opening, following inseam/inner fold	true	Half	3/8 in	-1/4 in	-1/4 in	31 in	1/4 in	1/4 in
Outseam	106	Measure from bottom edge of waistband/seam to bottom of garment along side seam/fold	true	Half	3/8 in	-1/4 in	-1/4 in	39 1/4 in	1/4 in	1/4 in
Front Rise	107	Measure from bottom edge of waistband/seam to crotch joining seam, following curve of front rise seam	false	Full	3/8 in	-3/4 in	-3/4 in	10 1/2 in	3/4 in	3/4 in
Back Rise	108	Measure from bottom edge of waistband/seam to crotch joining seam, following curve of back rise seam.	false	Full	3/8 in	-3/4 in	-3/4 in	14 3/4 in	3/4 in	3/4 in
Thigh Width Circumference (woven)	110	Measure from pant leg edge/seam to pant leg edge/seam straight across pant leg @ 1" below crotch and parallel to leg opening. Reporting half of the circumference measurement.	false	Half	1/2 in	-1/2 in	-1/2 in	11 1/2 in	1/2 in	1/2 in
Knee Width Circumference (Woven)	112	Measure from pant leg edge/seam to pant leg edge/seam at a point one-half of inseam and parallel to leg opening. Reporting half of the circumference measurement. (Note 1: If leg opening is asymmetrical, measure to a point that would be parallel to leg opening. Note 2: If pant leg is three-quarter length, indicate point of measure on spec sheet. Note 3: A general knee measurement from crotch seam of misses/women's 14", juniors 13", or large/plus women's sized 15" can be used. Indicate change on spec sheet. Measure children's at one-half inseam minus 1 1/2", and for men's minus 2")	true	Half	1 in	-3/4 in	-3/4 in	9 1/8 in	1 in	1 in
Leg Opening Width Circumference (Woven)	114	Measure from pant leg edge/seam to pant edge/seam straight across bottom edge of leg opening. Reporting half of the circumference measurement. (Note: If leg opening is contoured, follow contour and indicate measurement change on spec sheet).	true	Half	1/4 in	-1/2 in	-1/2 in	8 in	3/4 in	3/4 in



Cuff Height Pants	119	Measure from top of cuff edge straight down to bottom of cuff fold and leg opening.	true	Half	0 in	0 in	0 in	1 in	0 in	1/8 in
Fly Zipper Length	121A	Measure from top of fly/zipper opening straight down to bottom of fly/zipper opening at zipper stop or bar tack.	true	Full	0 in	0 in	0 in	6 1/2 in	0 in	1/4 in
Fly Zipper Width	121B	Measure top of fly/zipper at joining seam from edge/fold straight across.	true	Full	0 in	0 in	0 in	1 1/4 in	0 in	1/8 in
Applied Pocket Width	126	Measure from side of pocket to side of pocket along top edge of pocket (Note: For contoured or irregularly shaped pockets, take a second measurement and indicate point of measure in spec sheet.)	true	Full	0 in	0 in	0 in	6 in	0 in	1/8 in
Pocket Opening Within a Seam	127	Measure from top of pocket to bottom along edge of pocket opening	true	Full	0 in	0 in	0 in	5 1/2 in	0 in	0 in
Belt Loop Length	130	Measure from top of belt loop straight down/vertically to bottom of belt loop along center of belt loop. (Note: Fashion-forward or irregularly shaped belt loops may require further spec instructions. Indicate points of measure on spec sheet.)	true	Full	0 in	0 in	0 in	2 1/2 in	0 in	1/8 in
Belt Loop Width	131	Measure belt loop from edge of belt loop straight across / horizontally to edge of belt loop. (Note: Fashion-forward or irregularly shaped belt loops may require further spec instructions. Indicate point of measure on spec sheet.)	true	Full	0 in	0 in	0 in	1/2 in	0 in	1/8 in
Back Bottom Pocket Vertical	148E	Measure from waistband/joining seam/edge straight down to top edge of pocket.	false	Full	0 in	0 in	0 in	2 1/2 in	0 in	1/8 in
Back Bottom Pocket Horizontal	148F	Measure from center back straight across to side pocket at top edge.	false	Full	0 in	0 in	0 in	2 1/8 in	0 in	1/8 in
Knee Guard Height	CH4	Placement of knee guard ripstop from the bottom edge of the back pocket	true	Full	1/8 in	-1/4 in	-1/4 in	11 in	1/4 in	1/4 in
Knee Guard Width	CH5	Placement of knee guard in away from the inseam of the pant leg	true	Full	1/8 in	-3/8 in	-3/8 in	8 1/2 in	1/2 in	1/2 in
Applied Pocket Height	125	Measure from top pocket edge down to bottom pocket edge.	true	Full	0 in	0 in	0 in	6 in	0 in	1/8 in
Outseam Zipper Length	CH3	Measure the length of the outseam zipper from hem to end of the zipper length	true	Full	3/8 in	-1/4 in	-1/4 in	34 in	1/4 in	1/4 in
Cargo Pocket Length	90-012	Measurement from top of pocket to the bottom edge of pocket.	true	Full	1/8 in	0 in	0 in	8 in	0 in	1/8 in
Cargo Pocket Width	90-012	Measure from the left edge of pocket horizontally to the right edge of the pocket.	true	Full	1/8 in	0 in	0 in	6 1/2 in	0 in	1/8 in
Horizontal Cargo Pocket Placement from Inseam	90-014	Measure from the inseam edge horizontally to where the pocket edge begins. (This distance is symmetrical to the pant leg).	true	Full	1/8 in	0 in	0 in	1 1/2 in	0 in	1/8 in
Vertical Cargo Pocket Placement from Top of Back Pocket	90-013	From the bottom of the back pocket, measure down to where the top of the pocket begins.	true	Full	1/8 in	0 in	0 in	9 1/2 in	0 in	1/8 in
Knee Guard Placement Vertical	CH-1	Measure from bottom of waistband to top of the knee guard seam	true	Full	1/8 in	0 in	0 in	16 in	0 in	0 in



Horizontal Knee Guard Placement	CH-2	Measure from inseam to closest edge of the knee guard	true	Full	1/8 in	0 in	0 in	1 in	0 in	0 in
---------------------------------	------	---	------	------	--------	------	------	------	------	------



Sample Size: M

POINT OF MEASURE	CODE	HOW TO MEASURE	CRITICAL	TYPE	TOLERANCE	XS	S	M	L	XL
Waistband Depth	81	Measure from top of waistband edge straight down to bottom of waistband at waistband joining seam. [Note: If waistband is contoured, indicate measurement change on spec sheet.]	false	Full	0 in	1 3/8 in	1 3/8 in	1 3/8 in	1 3/8 in	1 1/2 in
Waistband Width Circumference (woven)	83	Measure from side of bottom band to side of bottom band along center of band, following natural contour of waistband. Reporting half of the circumference measurement.	false	Half	3/4 in	13 1/2 in	14 1/2 in	16 1/2 in	18 1/2 in	20 1/2 in
Hip Seat Width Circumference (woven pant)	93	Measure from edge of garment/side seam to edge of garment/side seam at a point up from crotch seam, following contour of waist. Reporting half of the circumference measurement.	true	Half	1 in	19 5/8 in	19 5/8 in	19 5/8 in	19 5/8 in	19 5/8 in
Inseam	105	Measure from crotch joining seam to bottom of leg opening, following inseam/inner fold	true	Half	3/8 in	30 1/2 in	30 3/4 in	31 in	31 1/4 in	31 1/2 in
Outseam	106	Measure from bottom edge of waistband/seam to bottom of garment along side seam/fold	true	Half	3/8 in	38 3/4 in	39 in	39 1/4 in	39 1/2 in	39 3/4 in
Front Rise	107	Measure from bottom edge of waistband/seam to crotch joining seam, following curve of front rise seam	false	Full	3/8 in	9 in	9 3/4 in	10 1/2 in	11 1/4 in	12 in
Back Rise	108	Measure from bottom edge of waistband/seam to crotch joining seam, following curve of back rise seam.	false	Full	3/8 in	13 1/4 in	14 in	14 3/4 in	15 1/2 in	16 1/4 in
Thigh Width Circumference (woven)	110	Measure from pant leg edge/seam to pant leg edge/seam straight across pant leg @ 1" below crotch and parallel to leg opening. Reporting half of the circumference measurement.	false	Half	1/2 in	10 1/2 in	11 in	11 1/2 in	12 in	12 1/2 in
Knee Width Circumference (Woven)	112	Measure from pant leg edge/seam to pant leg edge/seam at a point one-half of inseam and parallel to leg opening. Reporting half of the circumference measurement. (Note 1: If leg opening is asymmetrical, measure to a point that would be parallel to leg opening. Note 2: If pant leg is three-quarter length, indicate point of measure on spec sheet. Note 3: A general knee measurement from crotch seam of misses/women's 14", juniors 13", or large/plus women's sized 15" can be used. Indicate change on spec sheet. Measure children's at one-half inseam minus 1 1/2", and for men's minus 2")	true	Half	1 in	7 5/8 in	8 3/8 in	9 1/8 in	10 1/8 in	11 1/8 in



Leg Opening Width Circumference (Woven)	114	Measure from pant leg edge/seam to pant edge/seam straight across bottom edge of leg opening. Reporting half of the circumference measurement. (Note: If leg opening is contoured, follow contour and indicate measurement change on spec sheet).	true	Half	1/4 in	7 in	7 1/2 in	8 in	8 3/4 in	9 1/2 in
Cuff Height Pants	119	Measure from top of cuff edge straight down to bottom of cuff fold and leg opening.	true	Half	0 in	1 in	1 in	1 in	1 in	1 1/8 in
Fly Zipper Length	121A	Measure from top of fly/zipper opening straight down to bottom of fly/zipper opening at zipper stop or bar tack.	true	Full	0 in	6 1/2 in	6 1/2 in	6 1/2 in	6 1/2 in	6 3/4 in
Fly Zipper Width	121B	Measure top of fly/zipper at joining seam from edge/fold straight across.	true	Full	0 in	1 1/4 in	1 1/4 in	1 1/4 in	1 1/4 in	1 3/8 in
Applied Pocket Width	126	Measure from side of pocket to side of pocket along top edge of pocket (Note: For contoured or irregularly shaped pockets, take a second measurement and indicate point of measure in spec sheet.)	true	Full	0 in	6 in	6 in	6 in	6 in	6 1/8 in
Pocket Opening Within a Seam	127	Measure from top of pocket to bottom along edge of pocket opening	true	Full	0 in	5 1/2 in	5 1/2 in	5 1/2 in	5 1/2 in	5 1/2 in
Belt Loop Length	130	Measure from top of belt loop straight down/vertically to bottom of belt loop along center of belt loop. (Note: Fashion-forward or irregularly shaped belt loops may require further spec instructions. Indicate points of measure on spec sheet.)	true	Full	0 in	2 1/2 in	2 1/2 in	2 1/2 in	2 1/2 in	2 5/8 in
Belt Loop Width	131	Measure belt loop from edge of belt loop straight across / horizontally to edge of belt loop. (Note: Fashion-forward or irregularly shaped belt loops may require further spec instructions. Indicate point of measure on spec sheet.)	true	Full	0 in	1/2 in	1/2 in	1/2 in	1/2 in	5/8 in
Back Bottom Pocket Vertical	148E	Measure from waistband/joining seam/edge straight down to top edge of pocket.	false	Full	0 in	2 1/2 in	2 1/2 in	2 1/2 in	2 1/2 in	2 5/8 in
Back Bottom Pocket Horizontal	148F	Measure from center back straight across to side pocket at top edge.	false	Full	0 in	2 1/8 in	2 1/8 in	2 1/8 in	2 1/8 in	2 1/4 in
Knee Guard Height	CH4	Placement of knee guard ripstop from the bottom edge of the back pocket	true	Full	1/8 in	10 1/2 in	10 3/4 in	11 in	11 1/4 in	11 1/2 in
Knee Guard Width	CH5	Placement of knee guard in away from the inseam of the pant leg	true	Full	1/8 in	7 3/4 in	8 1/8 in	8 1/2 in	9 in	9 1/2 in
Applied Pocket Height	125	Measure from top pocket edge down to bottom pocket edge.	true	Full	0 in	6 in	6 in	6 in	6 in	6 1/8 in
Outseam Zipper Length	CH3	Measure the length of the outseam zipper from hem to end of the zipper length	true	Full	3/8 in	33 1/2 in	33 3/4 in	34 in	34 1/4 in	34 1/2 in
Cargo Pocket Length	90-012	Measurement from top of pocket to the bottom edge of pocket.	true	Full	1/8 in	8 in	8 in	8 in	8 in	8 1/8 in



Cargo Pocket Width	90-012	Measure from the left edge of pocket horizontally to the right edge of the pocket.	true	Full	1/8 in	6 1/2 in	6 1/2 in	6 1/2 in	6 1/2 in	6 5/8 in
Horizontal Cargo Pocket Placement from Inseam	90-014	Measure from the inseam edge horizontally to where the pocket edge begins. (This distance is symmetrical to the pant leg).	true	Full	1/8 in	1 1/2 in	1 1/2 in	1 1/2 in	1 1/2 in	1 5/8 in
Vertical Cargo Pocket Placement from Top of Back Pocket	90-013	From the bottom of the back pocket, measure down to where the top of the pocket begins.	true	Full	1/8 in	9 1/2 in	9 1/2 in	9 1/2 in	9 1/2 in	9 5/8 in
Knee Guard Placement Vertical	CH-1	Measure from bottom of waistband to top of the knee guard seam	true	Full	1/8 in	16 in	16 in	16 in	16 in	16 in
Horizontal Knee Guard Placement	CH-2	Measure from inseam to closest edge of the knee guard	true	Full	1/8 in	1 in	1 in	1 in	1 in	1 in